



Jagenberg Converting Solutions

Company overview

Agenda.

01 Jagenberg Group

02 Jagenberg Converting Solutions (JCS)

03 JCS Energy

04 Other battery solutions from Jagenberg Group

05 JCS Surfaces

01
Jagenberg Group



Key facts.

2023: ~370

Turnover in Mio. €

Locations in Europe,
China, India and the
USA

Locations

2023: ~1.430

Employees

Kleinewefers GmbH
86 %

Jagenberg AG
82 %

Equity ratio

100 %

Private ownership

7

Business parks



Executive Board
Dr. Christian Jostes
Dr. Stephan Witt

Sales by region.

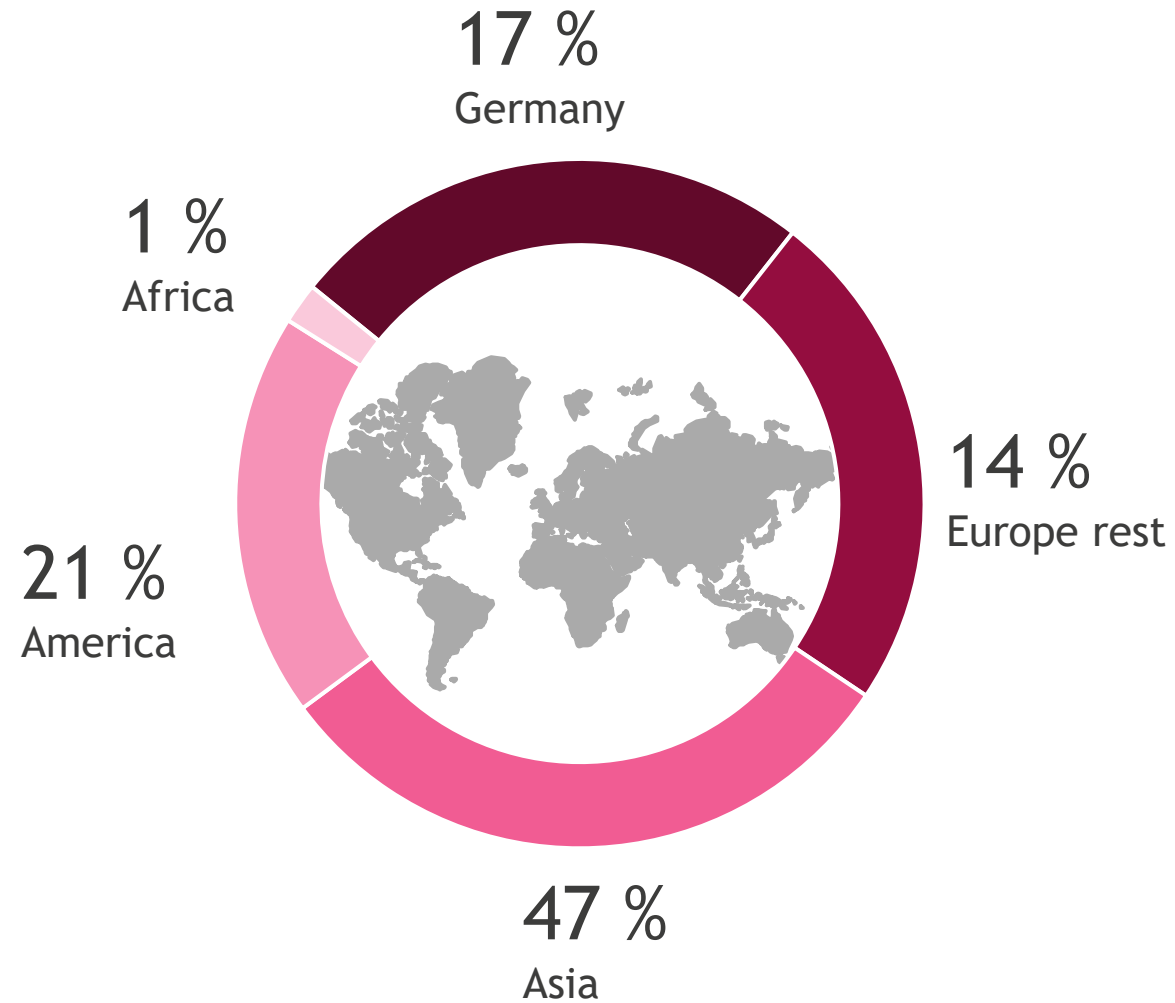

Fiscal year 2023

Kleinewefers Group

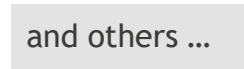
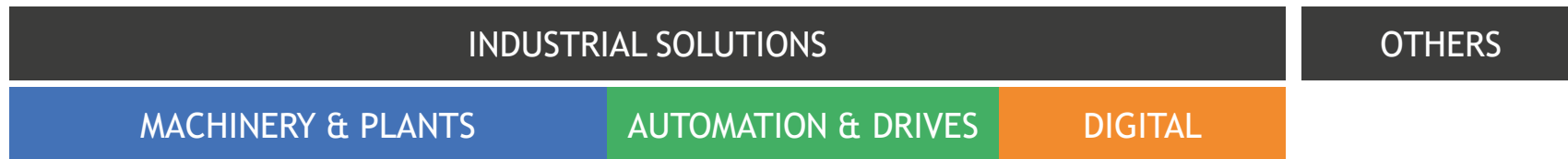

Kleinewefers/Jagenberg Group

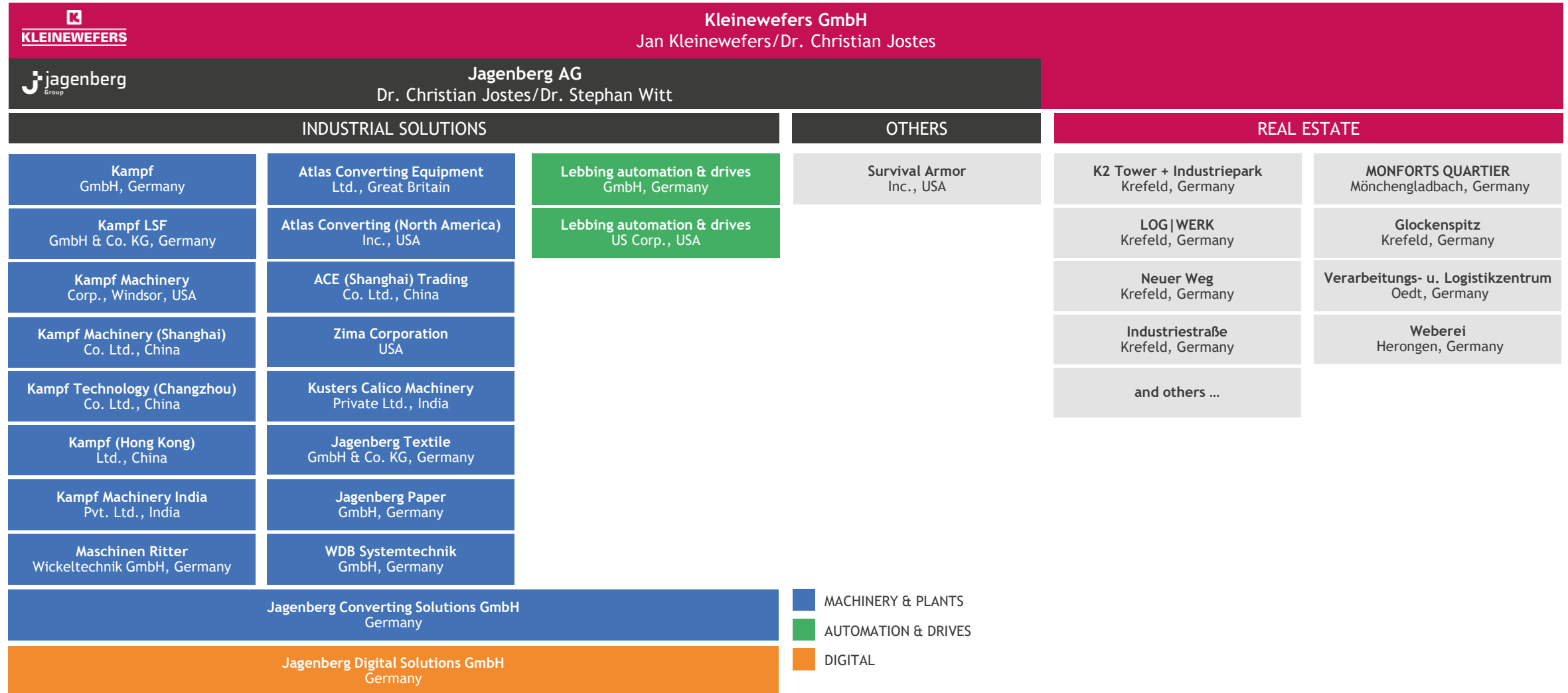

- MACHINERY & PLANTS
- AUTOMATION & DRIVES
- DIGITAL

Our mission statement. Create.Future.Together.



Create.

Innovative technologies for processing web-shaped materials are the historically grown core of the Jagenberg Group and have been our focus for over 140 years. We design creative and future-oriented solutions for our customers. Our thinking is entrepreneurial and our culture mid-sized. Short decision-making processes, a high level of action competence and an agile organization enable us to take successful steps into the future quickly and decisively.

Future.

We are ready to face the dynamic changes that the future holds for all of us - be it technological progress, digitization or climate change. Based on our values, we as a Group are actively working on innovative solutions to harness these megatrends in an economically and ecologically sustainable way for our customers and ourselves.

Together.

Together we are strong! This motto characterizes the cohesion in our group. We face the future as a strong team of doers and creative minds. Together with our customers, suppliers and partners, we create the future. Through a fair and trusting exchange, we learn from each other and build long-term and reliable partnerships together.

Our values. What we care about.

Trust.

Integrity.

Reliability.

Fairness.

Respect.

Openness.

Honesty.

Our fields of application.



Coating/
Laminating



Lacquering/
Embossing



Drying



Printing



Calendering



Slitting/Winding/
Spooling



Handling



Dyeing/Bleaching/
Mercerising

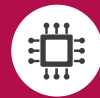

Automation
& Drives



Machine safety/
CE-conformity



Digitization

CARING FOR
THE FUTURE.



Sustainability Strategy. Caring for the Future.

Our sustainability strategy systematically signifies our commitment to take responsibility and minimize negative environmental impacts.

We respond to challenges by making the most of our strengths and skills and sharing our knowledge within the Group and with our suppliers and customers. Our comprehensive approach enables us to adopt new perspectives and develop sustainable solutions.



Sustainability Strategy. Our Sustainability Report.



Climate action



Resource awareness

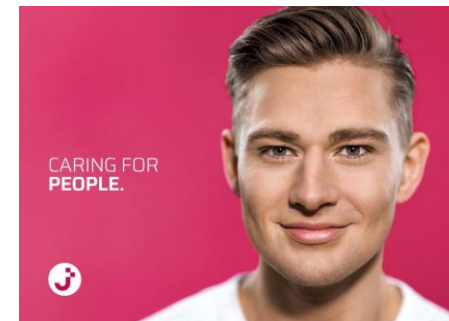

Attractive employer



Corporate governance

Sustainability Strategie. Guiding themes.

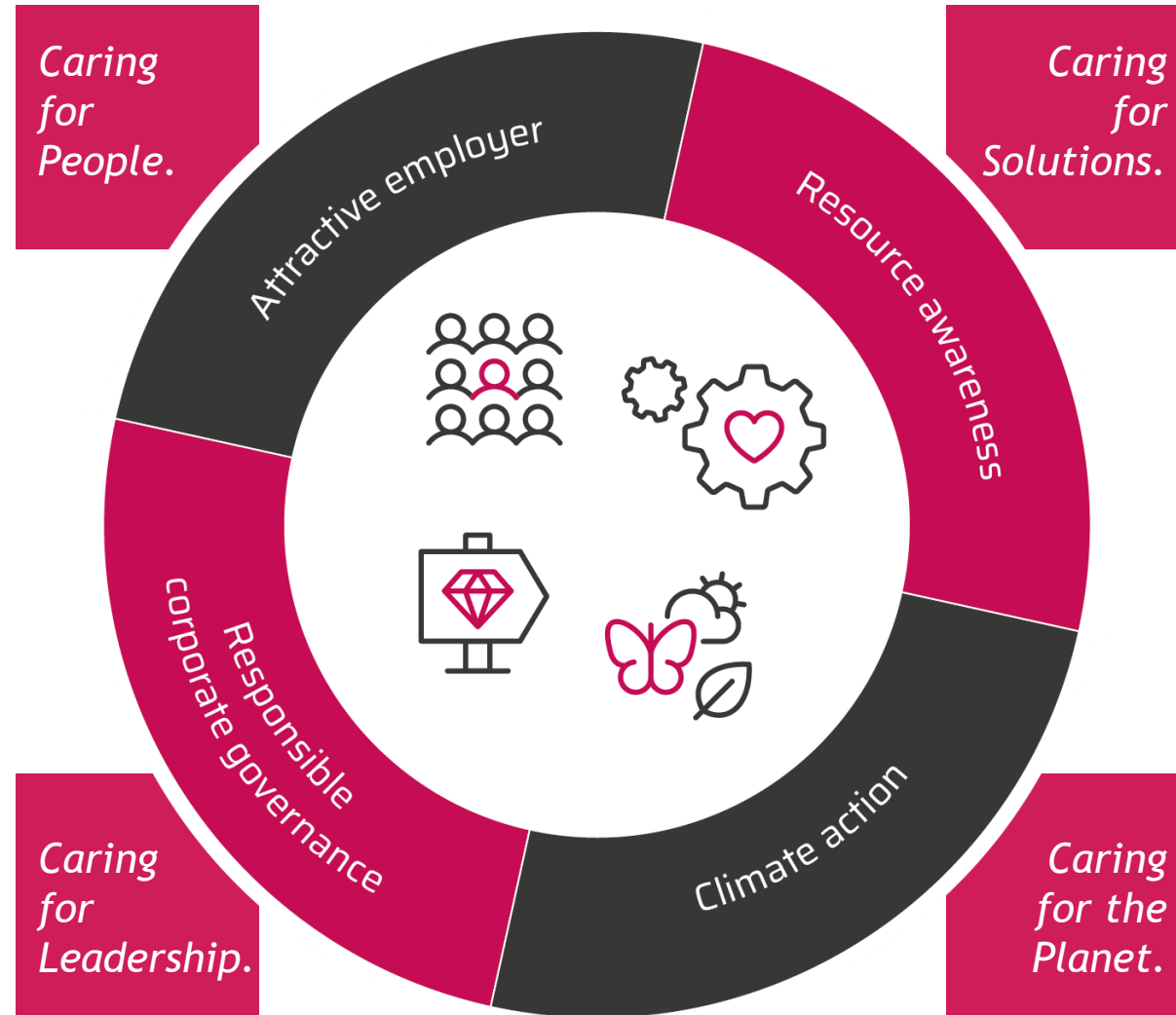

Sustainability Strategy.

Our fields of action.

We concentrate on the following action areas:



Climate action

We support the Paris Agreement and are actively helping to reduce carbon emissions.

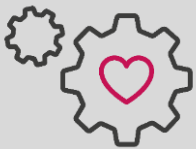

Resource awareness

We establish a responsible approach to the use of resources along the entire value chain.



Attractive employer

As an employer, we attach great importance to treating our employees responsibly and respectfully. We create attractive conditions to promote personal and professional development.

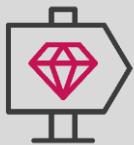

Responsible corporate governance

In line with our value system, we act on the basis of irreproachable conduct from an ethical and legal perspective.

02
Jagenberg
Converting
Solutions (JCS)

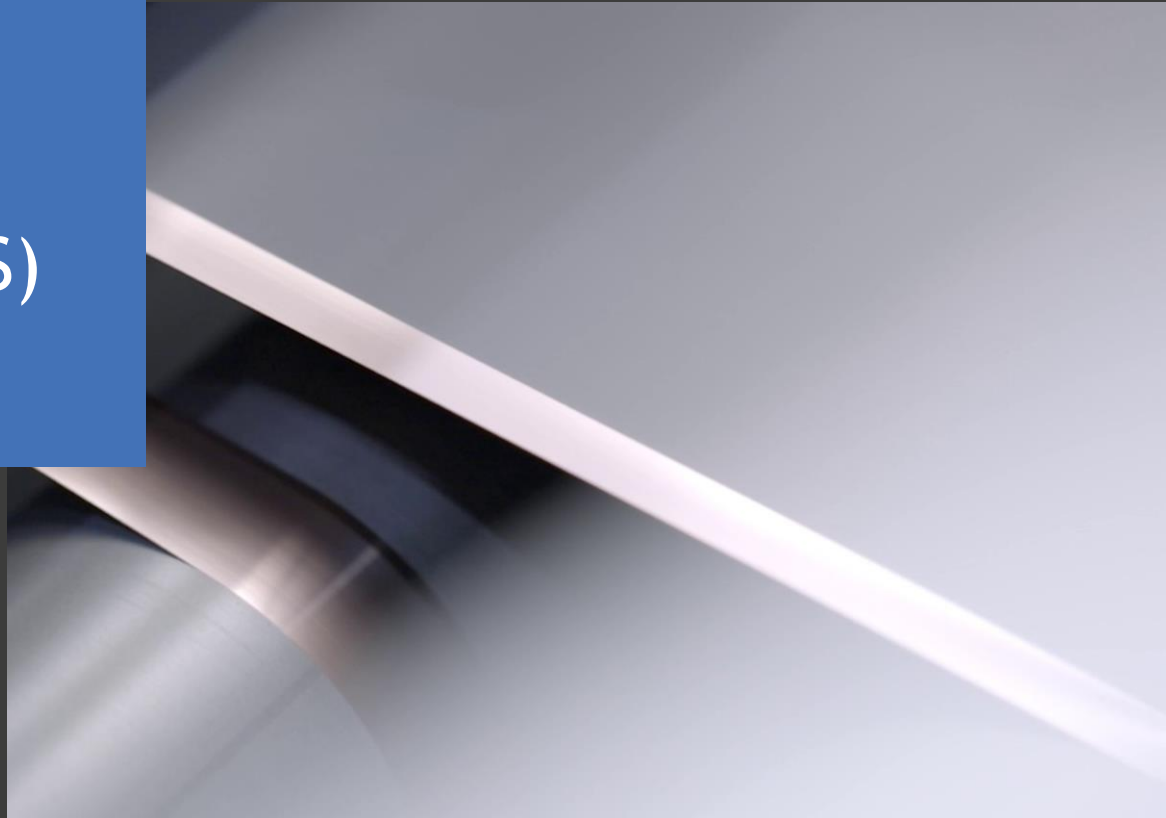



Integrate.Converting.Competences.

Your turnkey solution for the production of innovative foils for Surface and Energy applications.



The company at a glance

JCS integrates competences and technologies into a single solution for applications in the Energy and Surfaces industries. We thereby extend our own products with state-of-the-art components and services from other members of Jagenberg Group.

Purpose

Bocholt
Krefeld
Hamburg
Erlangen
Ostwestfalen-Lippe

Locations

>80 employees
and **>500**

located within other
Group companies

Employees

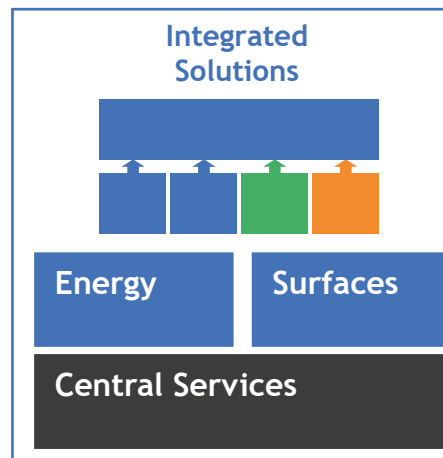

Management Team

Thomas Lebbing (Managing Director)
Guido Lebbing (Managing Director)
Steffen Heckmann (Managing Director)

Where we are active

Energy

Battery

Fuel Cell



Serial production equipment

Turnkey

Components

Process know how

Surfaces

Décor
printing

Coating



Décor printing
product lines

Coating
modular kit

Turnkey

Components

Process know how

Where we are located

Energy

Hamburg & Erlangen



Battery

Fuel Cell

Surfaces

Schloß Holte-Stukenbrock & Enger



Décor printing

Coating

Central Services

Krefeld & Bocholt



Finance &
Controlling

Marketing

Human
Resources

Sustainability

IT

M&A / PMI

Where you can find us

Energy **E**

Friesenweg 32a
22763 Hamburg
+49 40 2285 107-0

Am Weichselgarten 34
91058 Erlangen
+49 9131 932 86 80

Surfaces **S**

Hellweg 130
33758 Schloß Holte-Stukenbrock
+49 5207 986 76 02

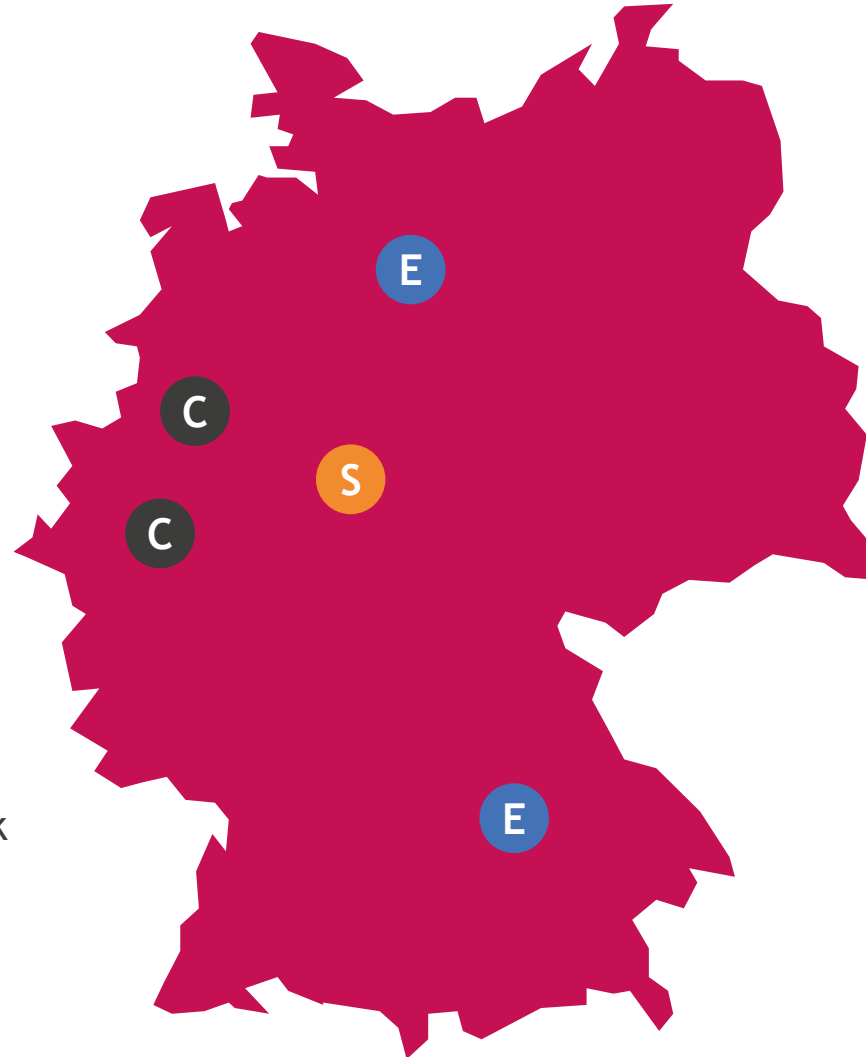

Central Services **C**

Kleinewefersstr. 1
47803 Krefeld
+49 2151 93 40 99-0

Konrad-Zuse-Straße 16
46397 Bocholt
+49 2871 2412-500

03
JCS Energy

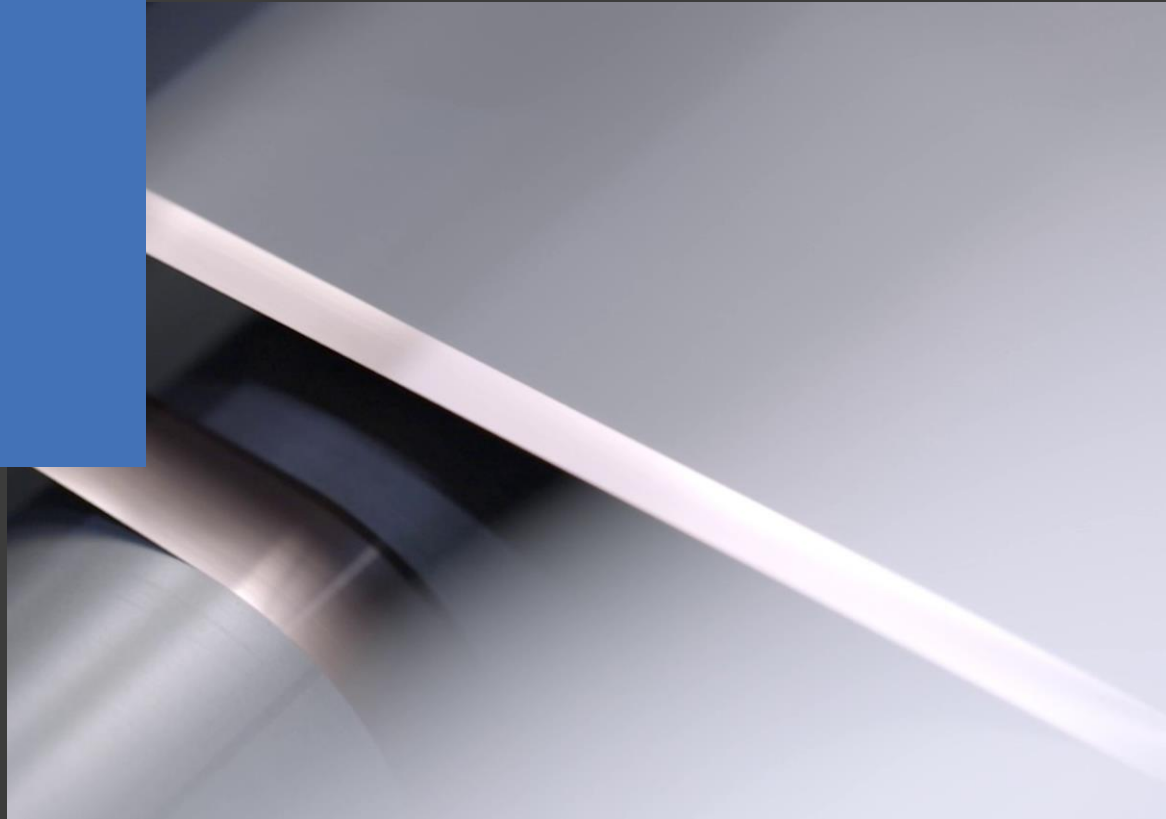

Solutions for your battery foil production



Integrate. Converting. Competences.

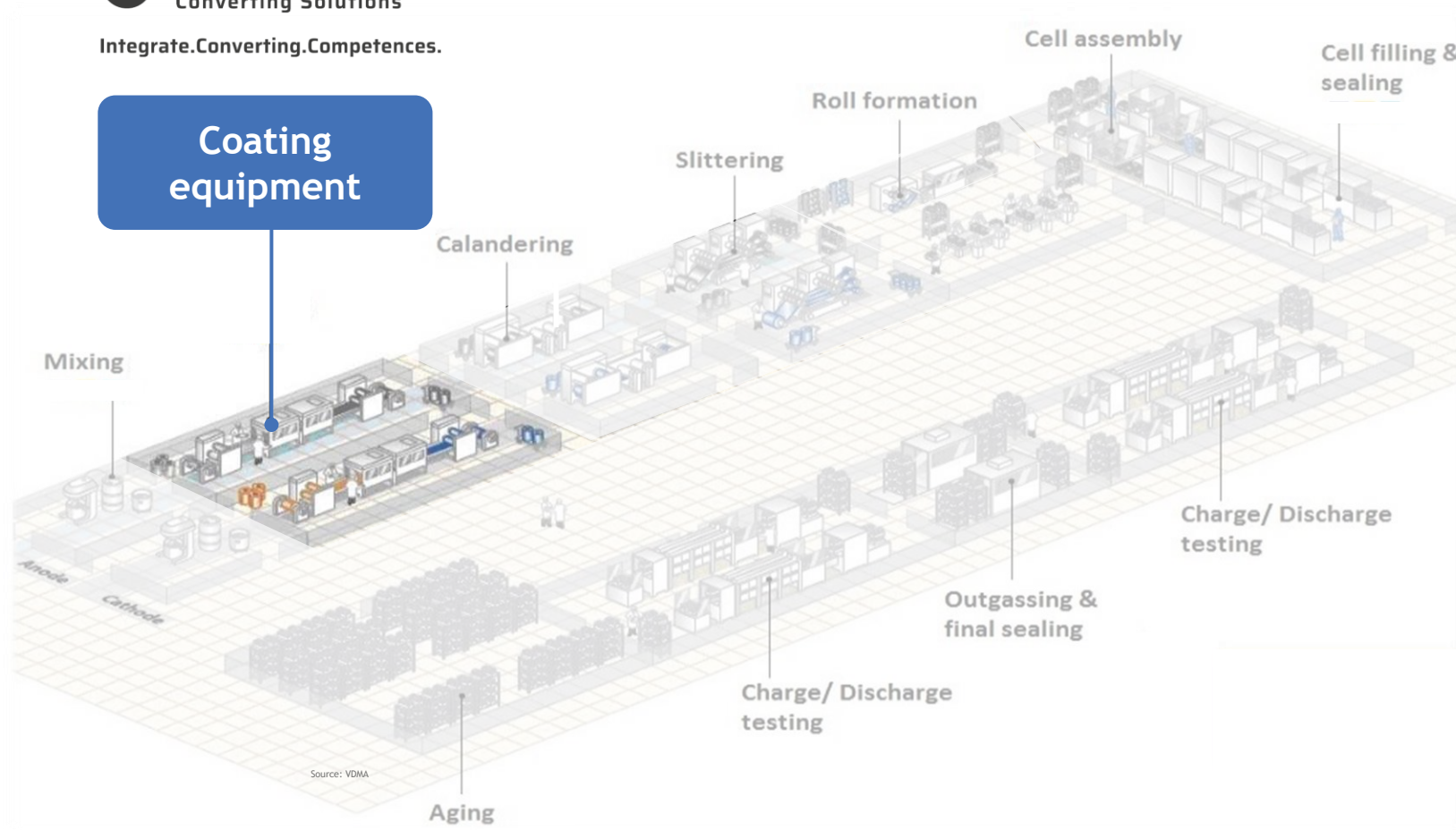

Our product portfolio



Production equipment
- turnkey

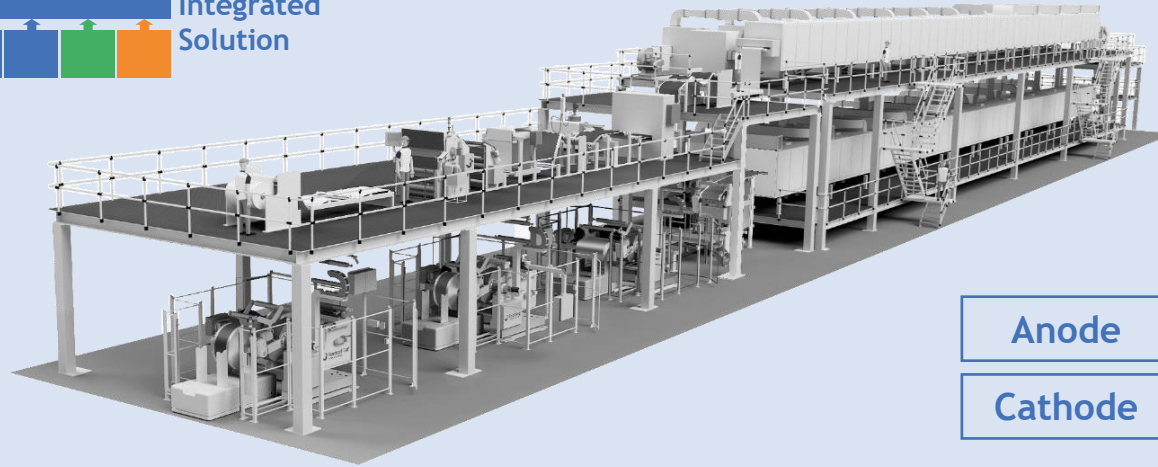

Anode

Cathode

What we offer

- State-of-the-art wet coating equipment - turnkey, suiting your individual needs.
- Integration of components from Jagenberg Group companies and 3rd party suppliers.



Components for
your individual
application

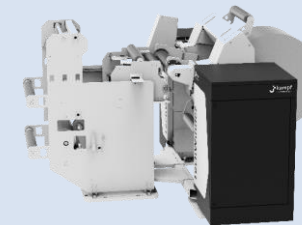
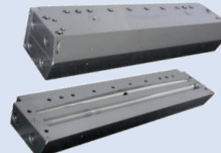
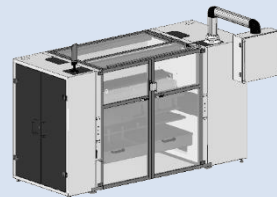
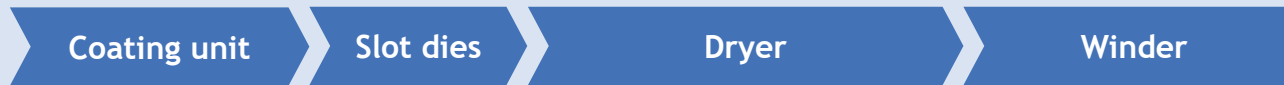

What we offer

- Components that are made for high performance and high precision.
- Proven technology for the battery industry.
- Made for your individual requirements

Configure your equipment with our standard components

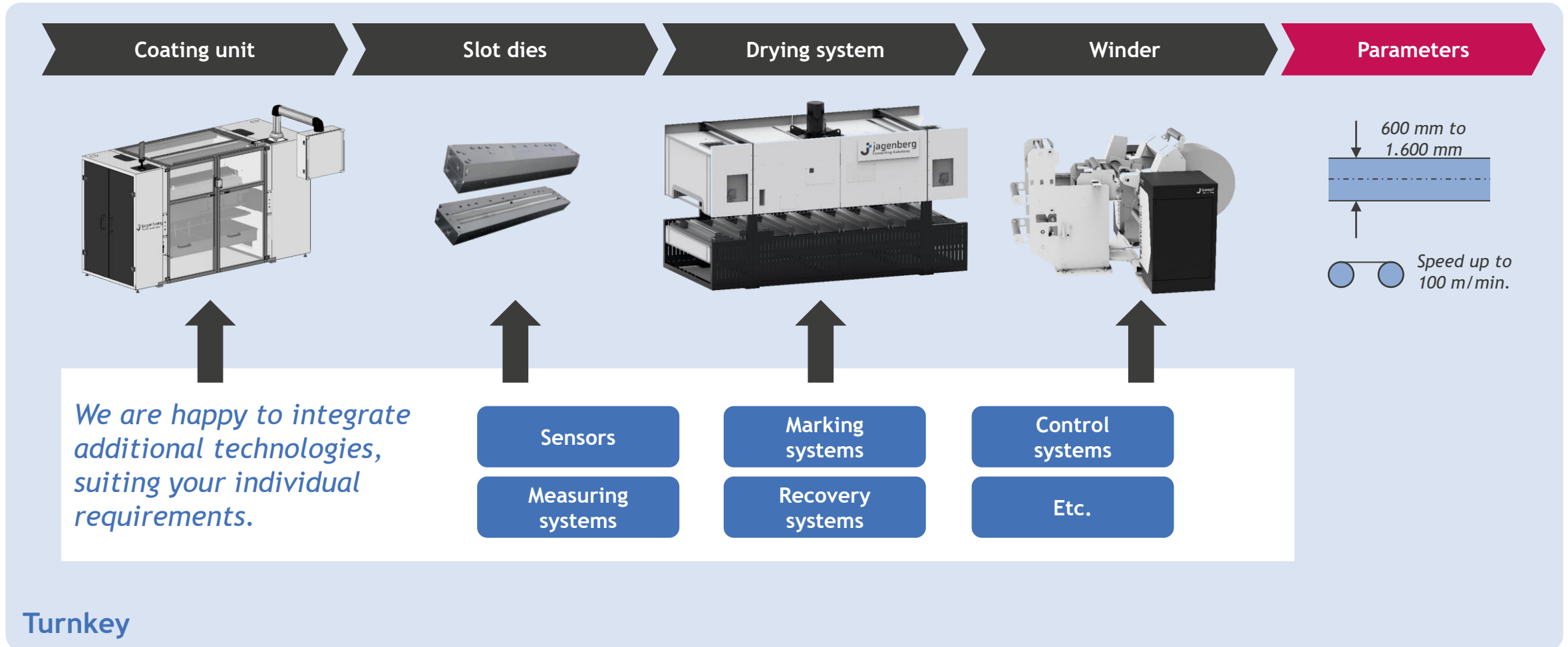

We can support you with our process know-how and technologies

Coating

Fluid measurements

CFD simulations

Process window calculations

Practical feasibility studies (lab scale)

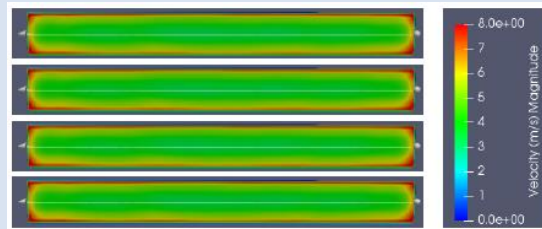
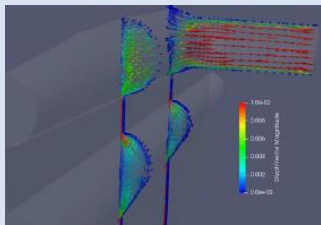

High precision Slot Die

Tailor-made equipment that matches the coating process and plant design.

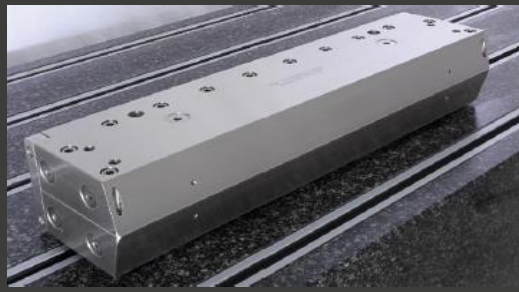

Drying

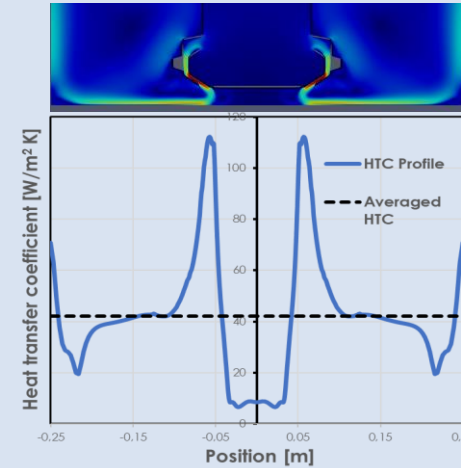

Drying optimization

Drying curve calculations

CFD simulations

LamiFlow Nozzle

The patented impingement-free nozzle provides a homogeneous temperature profile at high drying performance.



We invest in the development of our equipment

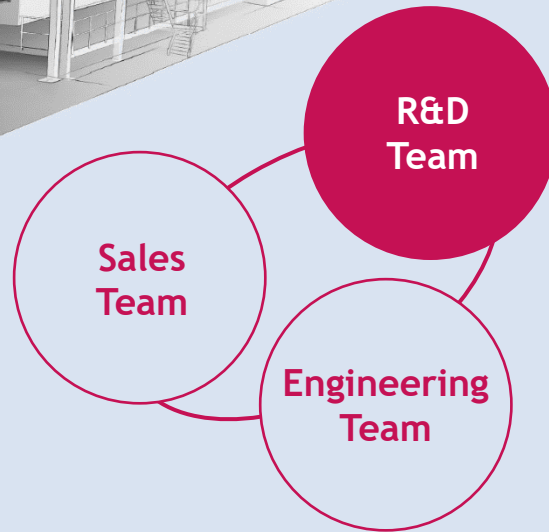
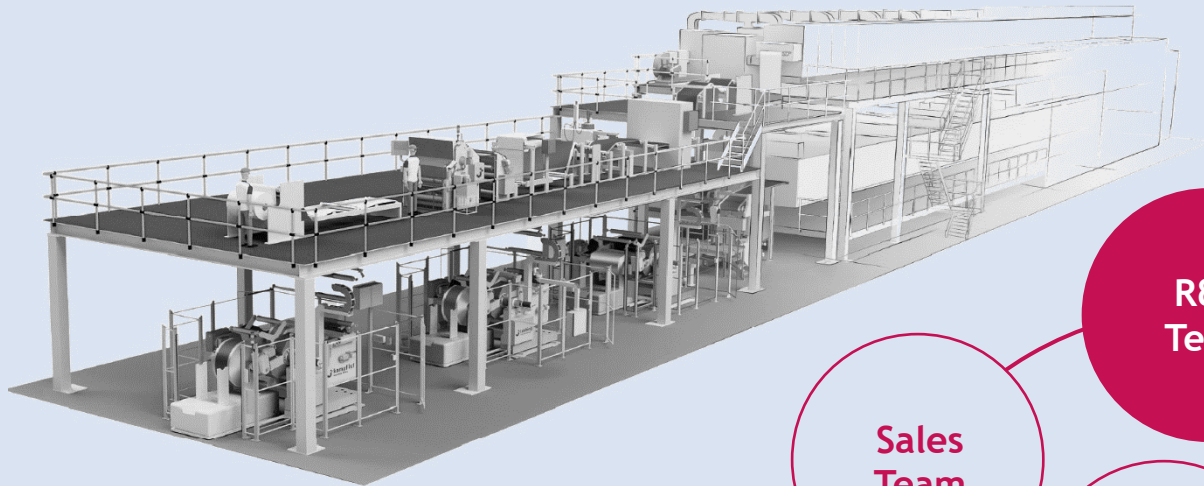

Associations & Research Institutions



How we can contribute to your success



Integrate. Converting. Competences.

We focus on providing innovative and sustainable solutions for the battery industry.

Our added value.

Advanced Solutions.



Increasing productivity.



Total cost of ownership.



Reduction of waste.



Carbon footprint.



Advanced technologies as enabler.

Process engineering

Technology

Automation & Drives

Digitization

Handling systems

Functional safety

Connectivity

Production equipment - turnkey for electrode production



Integrate. Converting. Competences.

- Coating unit
- Slot dies
- Dryer

- Process technology
- Project management
- Site management

- Single point of contact
- Installation
- Commissioning

- Process optimization
- Start-up
- 24/7 hotline

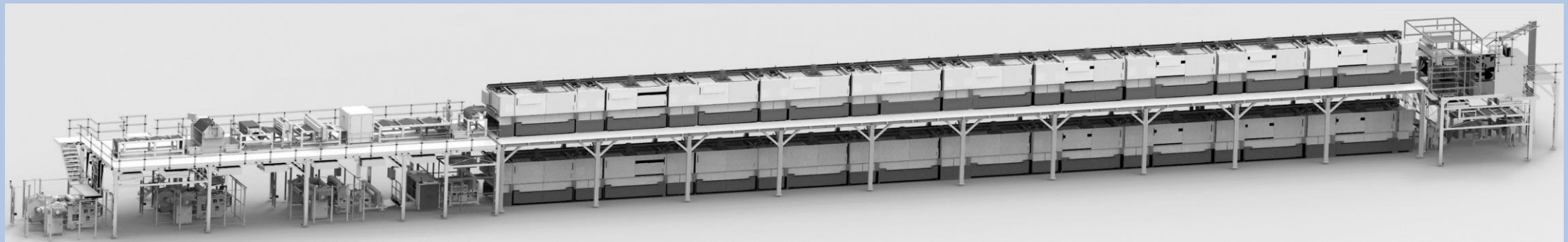

kampf lsf
Jagenberg Group
Converting.Processing.Unlimited.

- Unwinder
- Rewinder
- Slitter

kampf
Jagenberg Group
Slitter.Winder.Kampf.

- Slitter

lebbling
Jagenberg Group
Automation.Drives.Future.

- Automation
- Safety

jagenberg
Digital Solutions
Connect.Develop.Advance.

- Digitization

From our network of partners

- Measurement systems
- Steel work
- Others

Turnkey equipment - scope and contractual setup

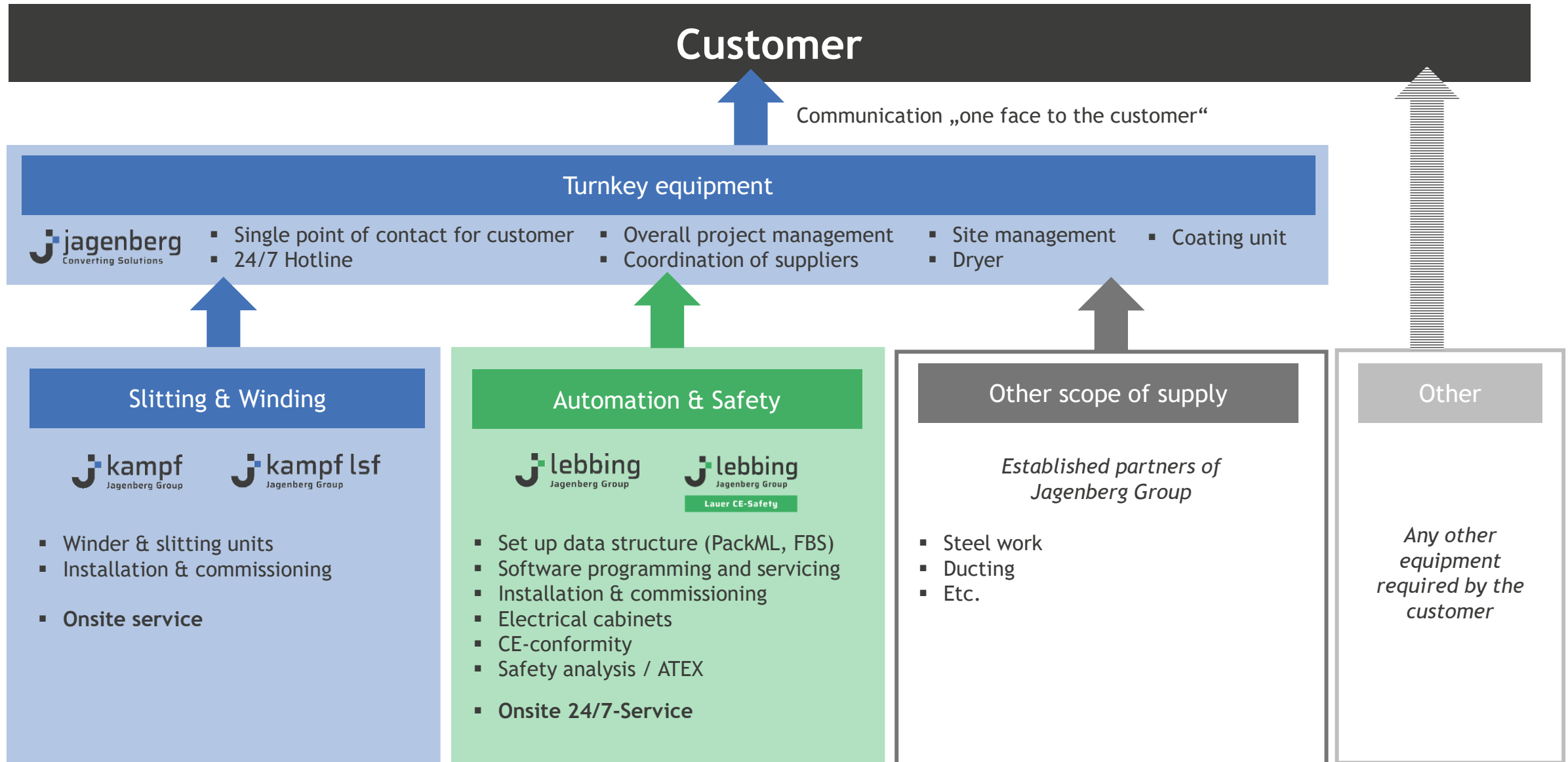

Our offering

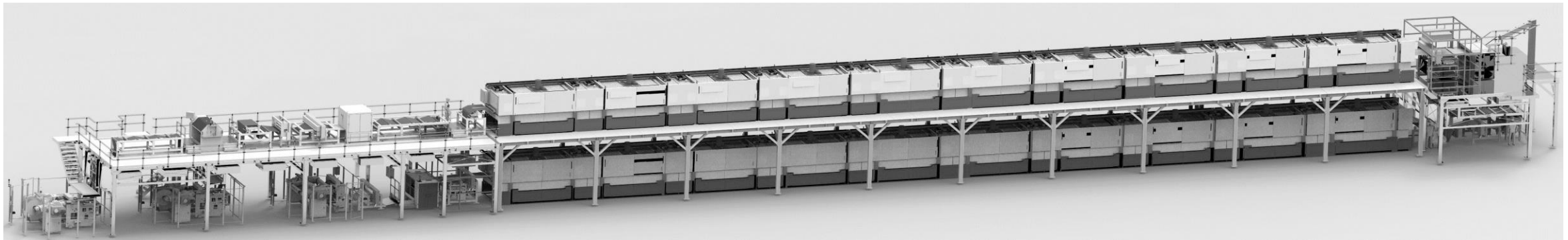

Converting.Processing.Unlimited.

Special machine engineering company which develop special solutions for processing and finishing of web-shaped materials

Turret rewriter

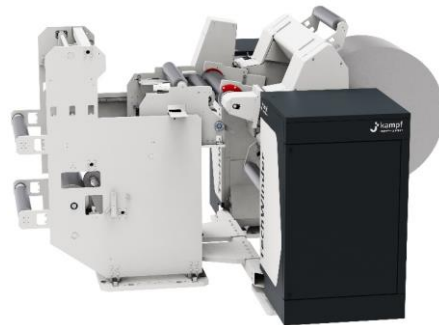

Slitting unit

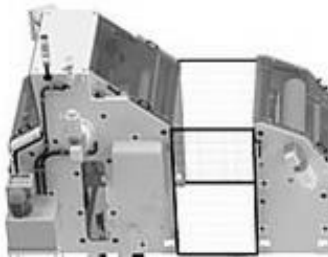

Turret unwinder with auto-splice



Slitter.Winder.Kampf.

The world's largest manufacturer of winders and slitters for demanding web materials and technological leader for 100 years

Rewinder, slitter, unwinder.

In the manufacturing processes of cathodes and anodes for Lithium-Ion Batteries, turret unwinder and turret rewriter type EvoWinder are used before and after coating lines and calender systems. The specially designed turret systems enable continuous operation without any restrictions in speed and productivity.

Our offering

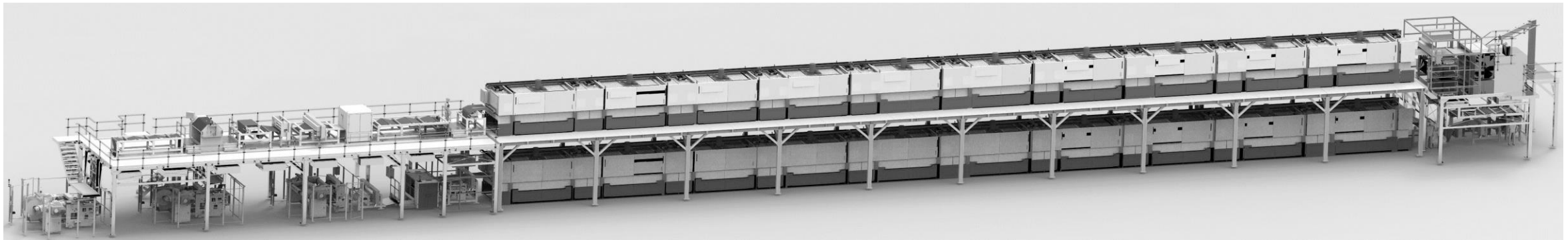

Integrate. Converting. Competences.

Specialist for coating technologies that develops and engineers the right solution for your individual application.

Coating Unit

High precision die coater.
High speed coating from pilot- to large-scale production.

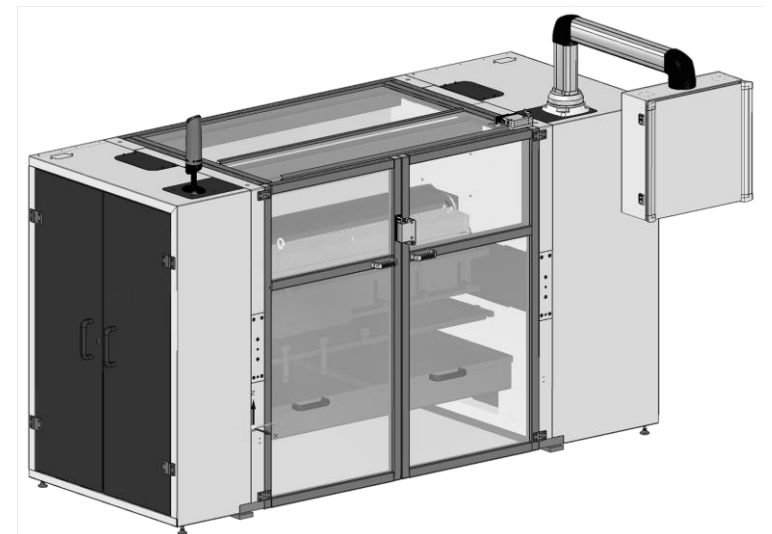
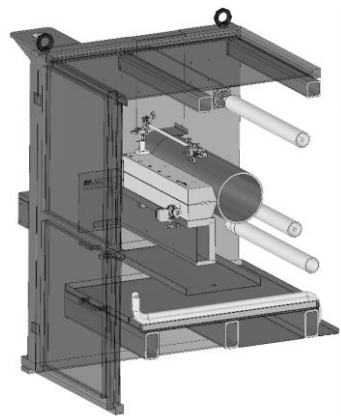

Our offering

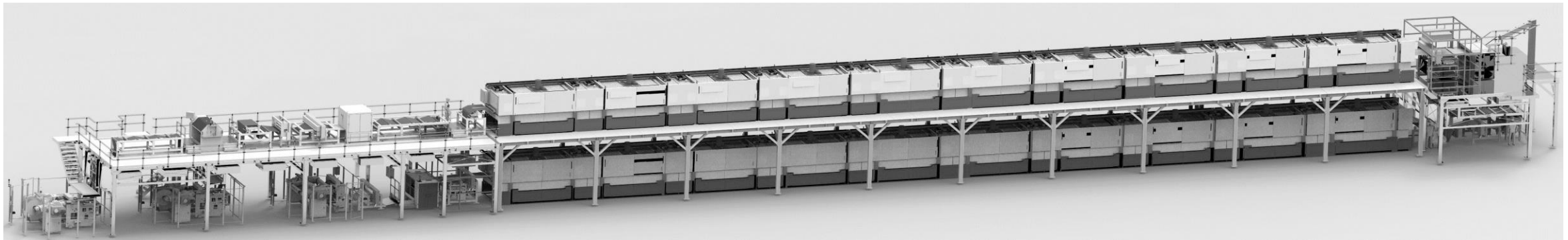

Integrate. Converting. Competences.

Partner for state-of-the-art drying technology engineered and built in Germany

Advanced drying technology.
The drying process affects the final battery performance to a large extent. We fit the best dryer for your requirements.

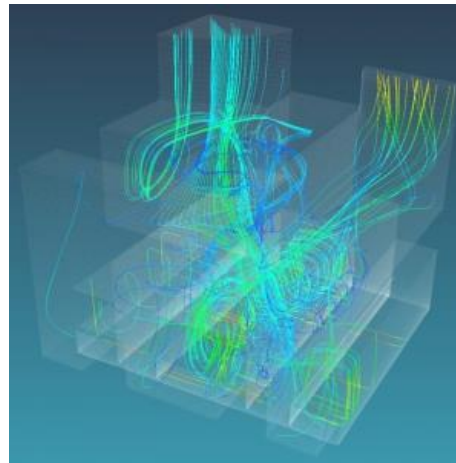

Dryer



Our offering

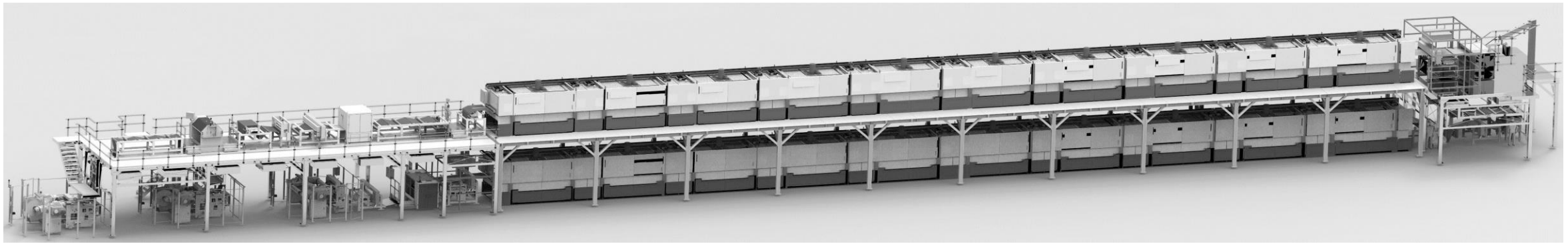

Automation.Drives.Future.

Partner for all questions concerning drive and automation technology. Conceptual design, construction and production of electrical and switchgear systems

Drive technology

Mechatronic drive concepts.
From operating units to cabinet rows or complex switchgear containers for large systems.

Control technology

PLC & HMI operating and monitoring systems.
Pioneering technologies for operation and monitoring and for process visualization.

Data systems

Software development/ visualization systems.
Development of comprehensive visualizations with maximum transparency across all layers.

Panel shop

CE and UL certified panel shop.
With our own panel shop, we provide highest reliability for your delivery schedule.

Start-up & Service 24/7

Electrical installation / commissioning.
Team of globally experienced professional technicians and engineers for the installation and commissioning of systems “on-site”.



Our offering

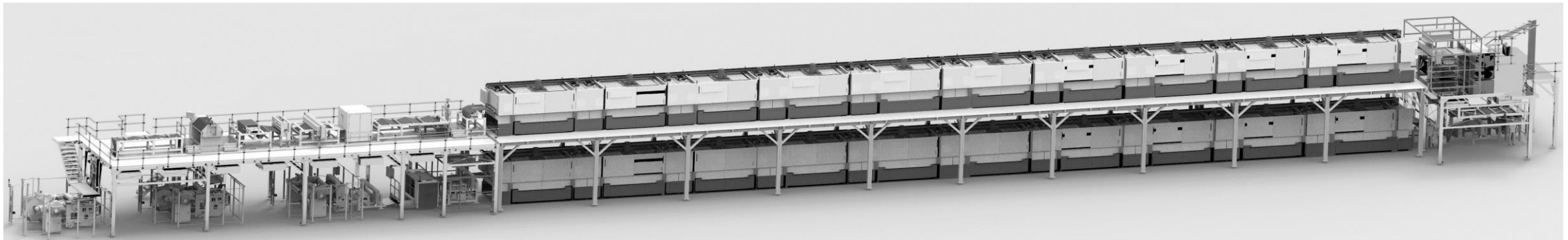

Lauer CE-Safety

Expert in all issues relating to CE marking, risk assessment, functional safety, assembly instruction and machine safety

CE Marking & Risk assessment

CE compliance.

From precise risk analysis and risk evaluation following the applicable directives to comprehensive research and analysis of standards (i.e. DIN EN ISO 12100) as well as safety-related review of machinery under construction.

Functional Safety Engineering (FSE)

EN ISO 13849 application.

Our specially trained control engineers support machinery constructors by designing, verifying and validating safety functions.

ATEX 114 Directive 2014/34/EU.

User manuals & assembly instructions

Operating instructions and technical documentation.

We provide full service in creating complete preparation of operating and assembling instructions or alternatively evaluates pre-prepared technical documentation and supports the creating process at the customers site by training.

Professional CE-software

Directives, risks and draw up manuals.

With the right software, these tasks can be completed faster and more efficiently. We offer proven CE-software products that are continuously updated.

Our offering

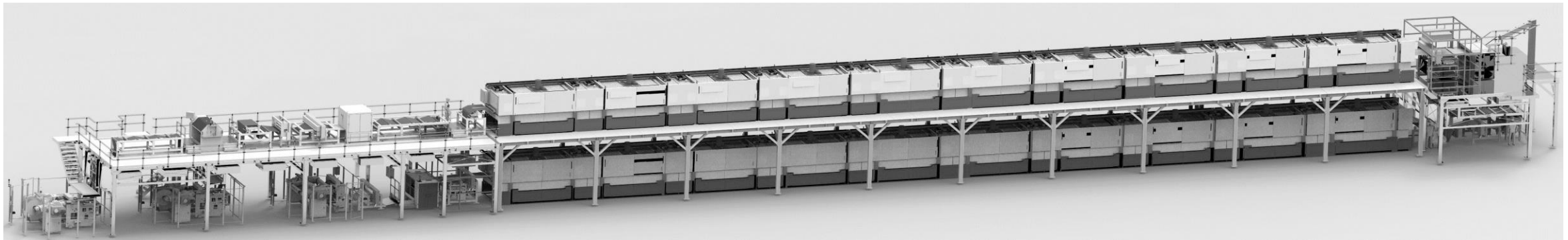

Connect. Develop. Advance.

We focus on improving processes in production and thus optimizing the efficiency of companies across the entire value chain

IloT platform

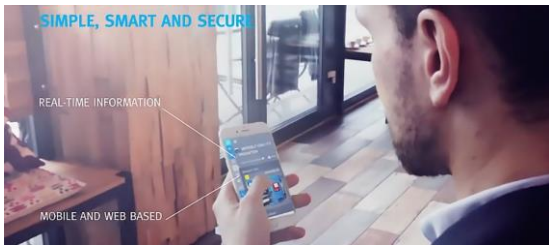

IloT for your equipment. The platform offers digital intelligence for manufacturing. It connects machines, production and companies. It monitors production and bundles all relevant information for high production quality, resource conservation and low downtimes

Data management



Digitized manufacturing. Manufacturing is brought to a new level. Our solutions enable direct interfaces to ERP-Systems, communication to MES-Systems as well as support traceability through roll protocols

Smart sensors



Smart data harvester. There are many different factors that can influence maintenance cycles and product quality. the@dge unit is simply installed and connected via LAN cable (PoE) and communicates with our IloT platform.

Turnkey equipment - project example

Equipment for cathode and anode production

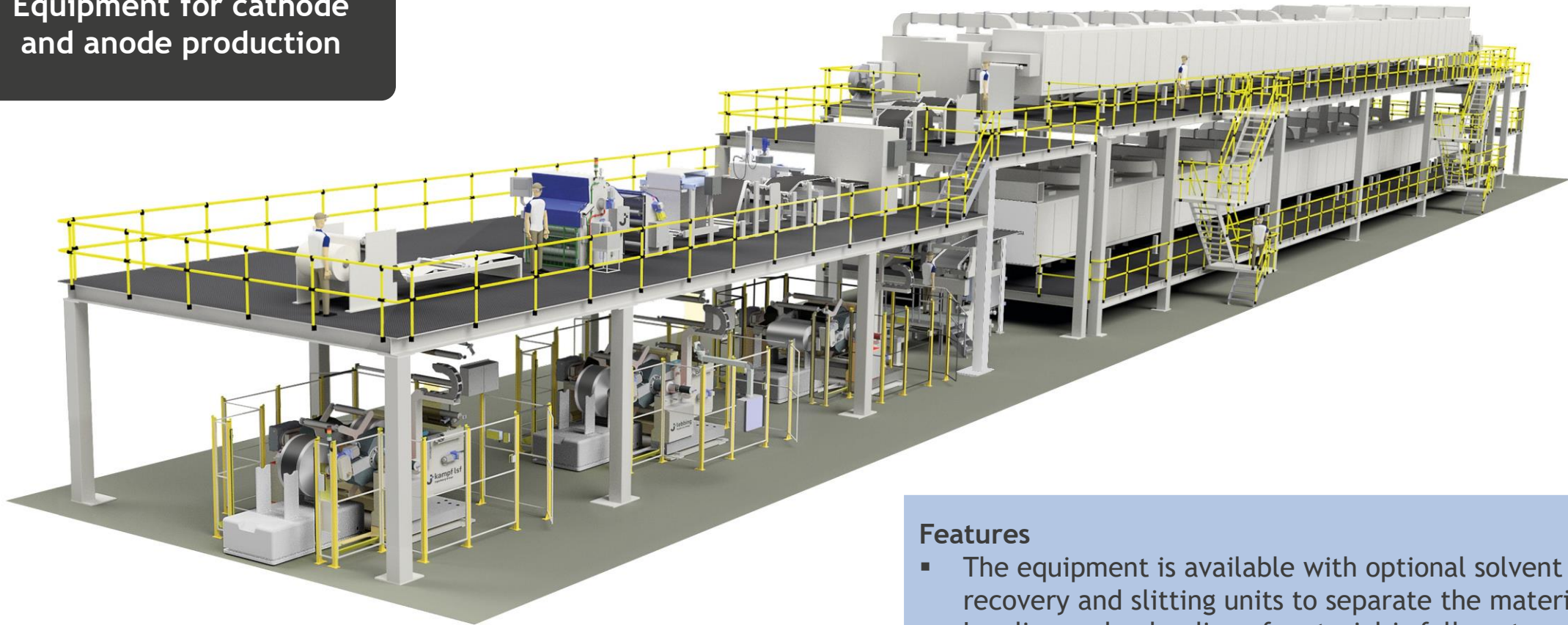

Features

- The equipment is available with optional solvent recovery and slitting units to separate the material.
- Loading and unloading of material is fully automated with Automated Guided Vehicles.
- The equipment is connected to the MES-system.

References - Tandem coating lines for battery electrodes



How to reach us

Thomas Lebbing
Managing Director Energy



thomas.lebbing@jagenberg-converting.com

04
Other battery
solutions from
Jagenberg
Group



INDUSTRIAL SOLUTIONS

MACHINERY & PLANTS

AUTOMATION & DRIVES

DIGITAL



More solutions along the battery production process

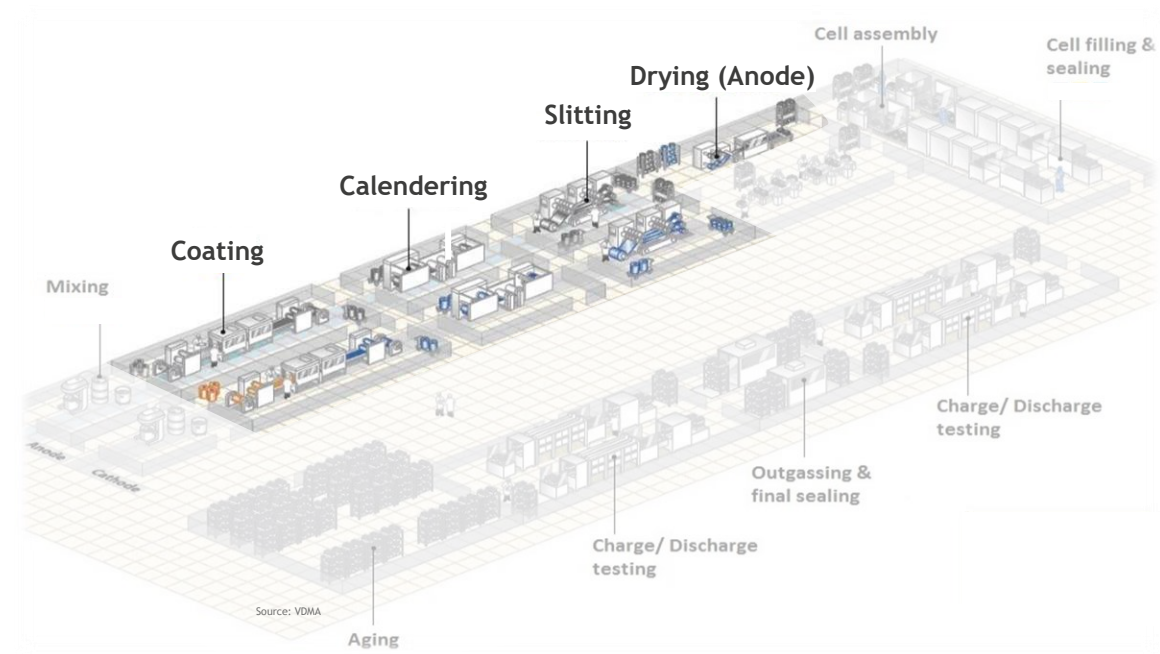
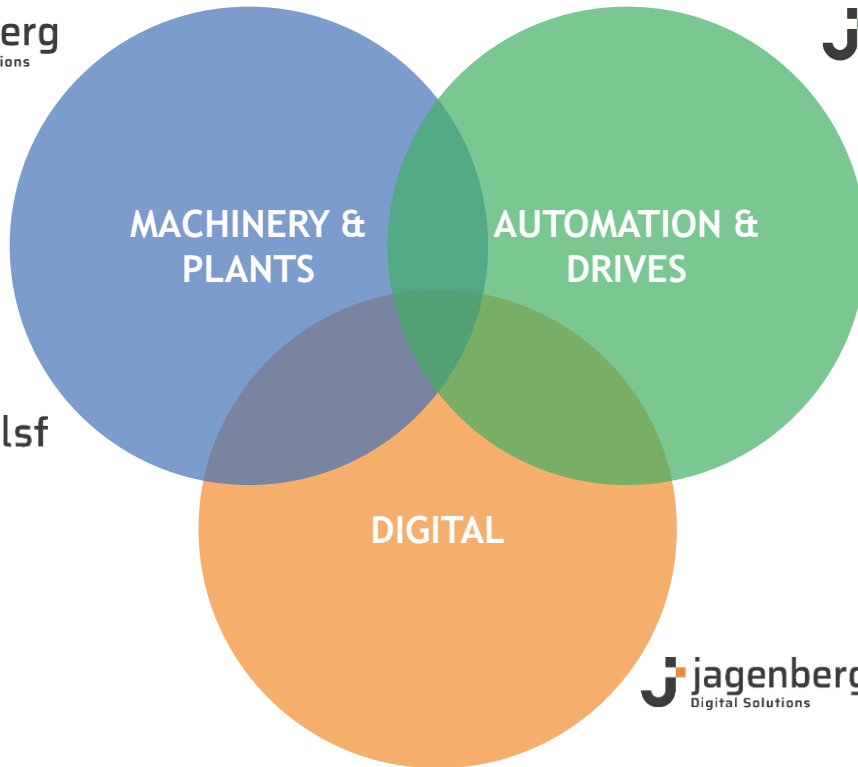

Slitting & Winding solutions for the battery industry

Separator

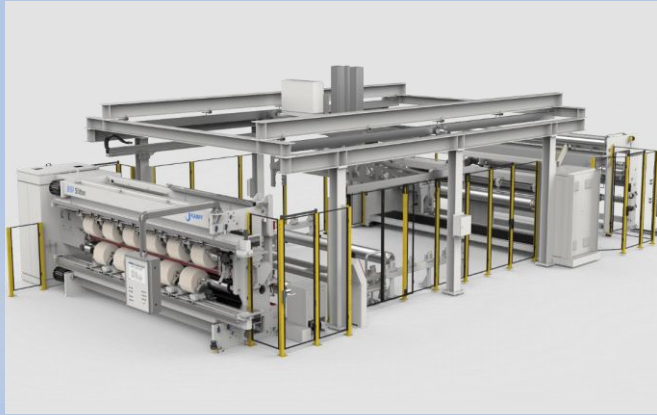

- Full width winder
- Primary slitter
- Secondary slitter

Anode & Cathode

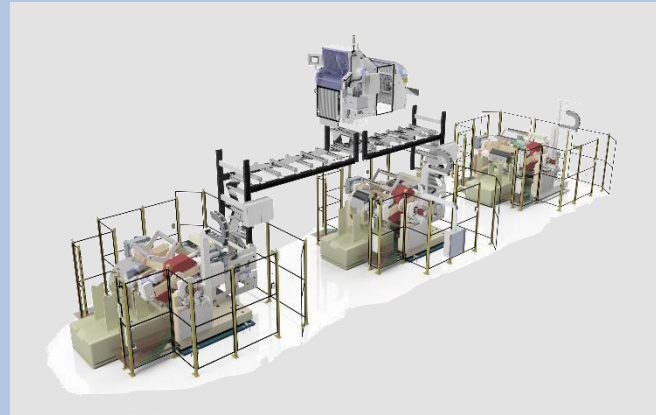

- Turret rewinder
- Turret unwinder
- Splicing systems, Slitting units

Anode & Cathode

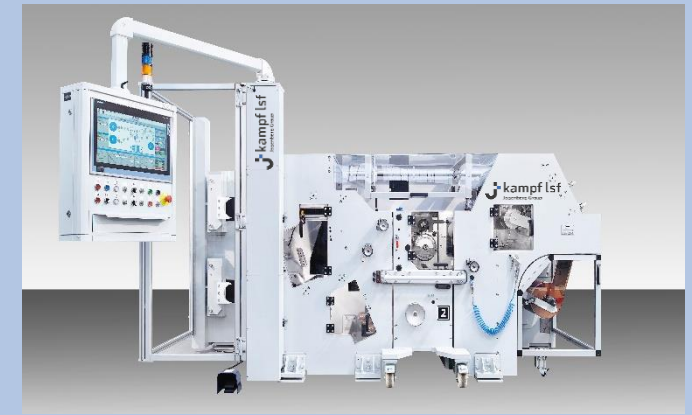

- Pilot line slitter rewriter
- Production machines

Automation

Consistent increase in productivity for you:

- Planning
- Simulation (Digital Twin)
- Continuous communication & data flow
- Project management and implementation

Added value
from a single source.



Digitalization

Integrative digital added value for you:

- Production overview
- Digital roll protocols
- Connectivity
- Data mining

References - Fully automated slitting cell for BSF

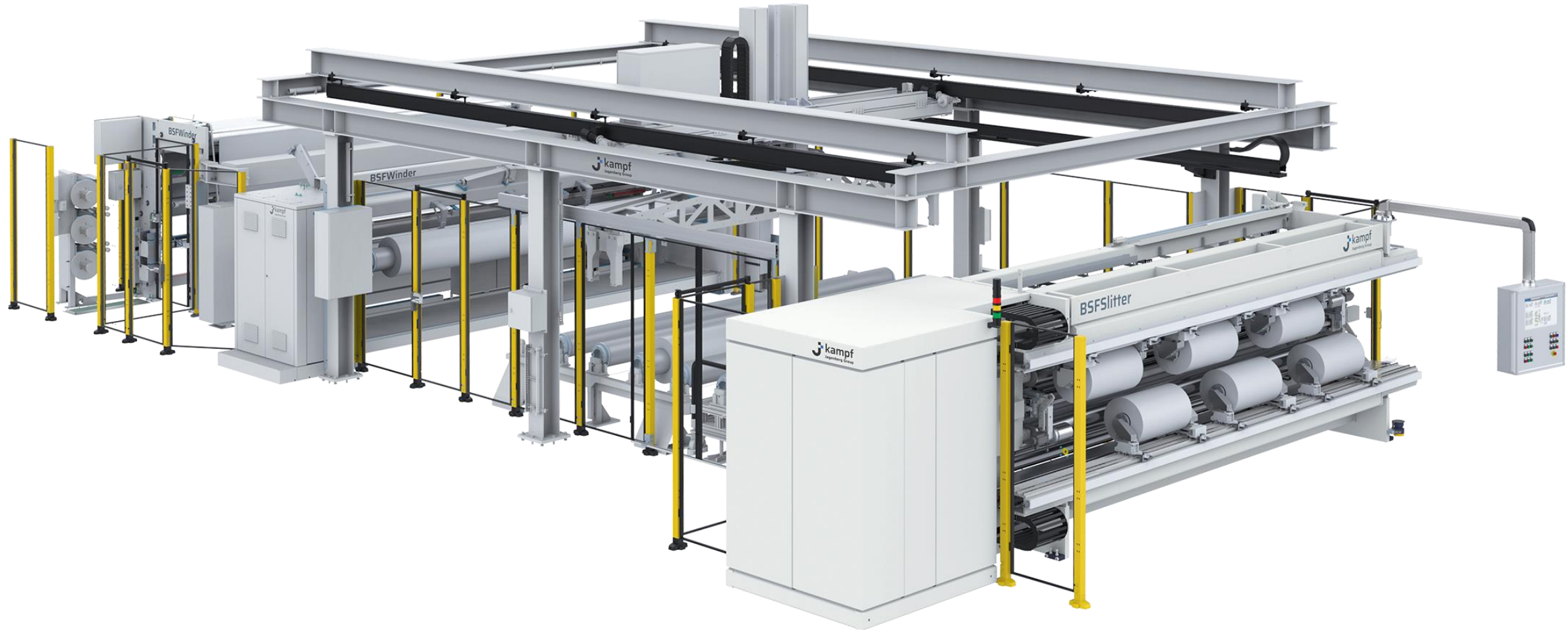

Machinery scope

- Non Stop turret winder
- Primary slitter

Automation scope

- Roll storage
- Portal robot

Digitization Scope

- IIoT Platform
- MES / ERP communication
- Cloud connection

References - Slitting for Anode and Cathode



Source: BMW Group, Battery Cell Competence Center

How to reach us

Thomas Lebbing
Managing Director Energy



*“We are happy to connect
you with our partners from
Jagenberg Group”*

thomas.lebbing@jagenberg-converting.com

05
JCS Surfaces



State of the art equipment for printing applications



Production
turnkey
equipment



Components for
your individual
application

Winder



Printing, Lacquering &
Coating unit

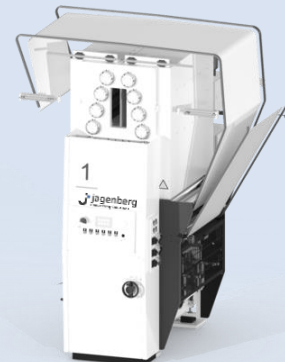

Re-winder

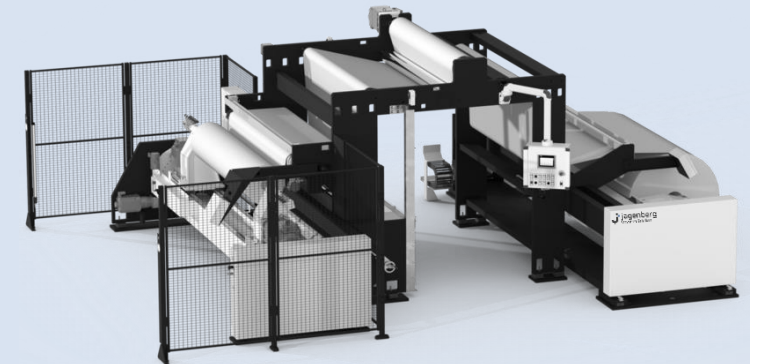

Product lines for printing applications

Jupiter

Performance Paper

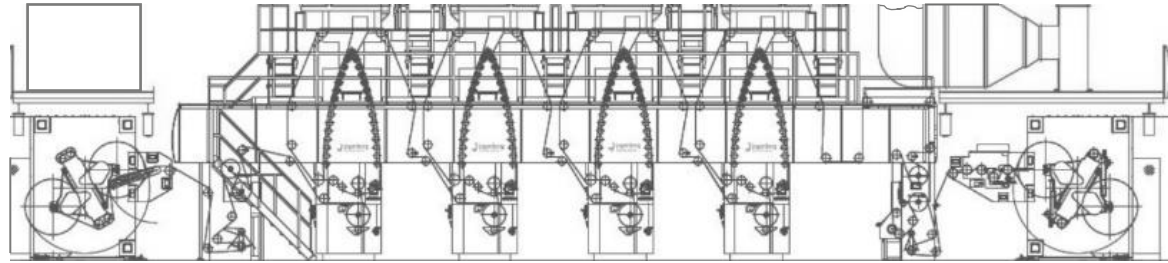

Main characteristics

- Higher speed
- Increased efficiency
- Many options
- New technologies

Saturn

Performance Film



Main characteristics

- Optimized for film (PVC)
- Advanced drying technology

Neptune

Economy Film & Paper



Main characteristics

- Moderate speed
- Highly standardized components
- Designed in Germany, built in India

Our turnkey solutions

Project Mgmt.

Turnkey



Integrate.Converting.Competences.

Lead
engineering

Technology

Your general contractor.
Integrates all competences in state-of-the-art
surface production lines

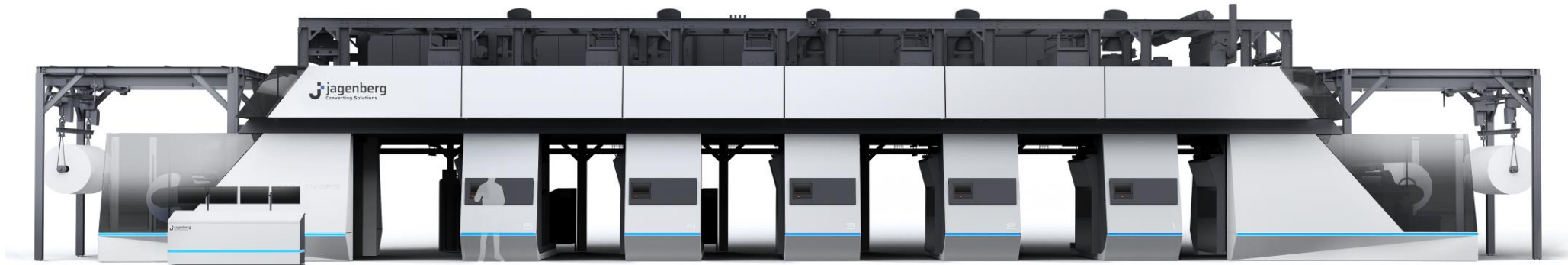

Converting.Processing.Unlimited.

Unwinder

Rewinder

Coating units



Unique.Surface.Ideas.

Web handling

Printing units

Lacquering units



Textile.Converting.Excellence.

“Neptune”

Standardized
Components



Automation.Drives.Future.

Automation

Safety



Connect.Develop.Advance.

Digitization

Our offering

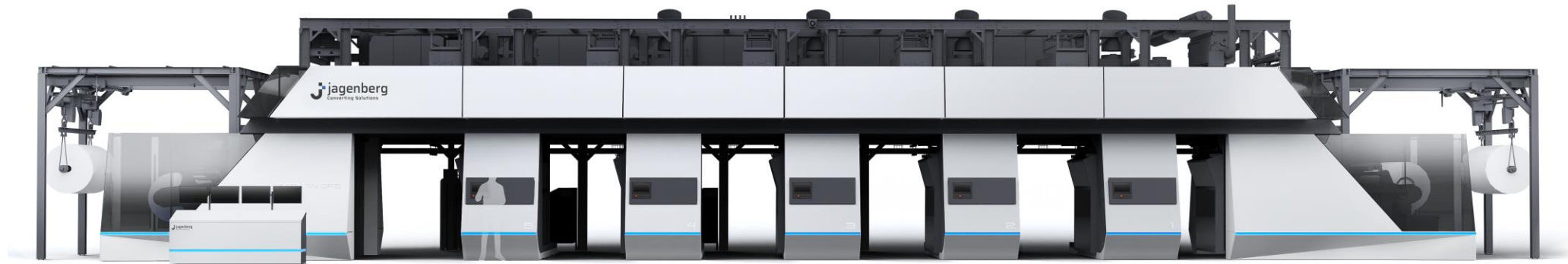

Converting.Processing.Unlimited.

Special machine engineering company which develop special solutions for processing and finishing of web-shaped materials

Turret unwinder with auto-splice

Turret rewinder

Coating units

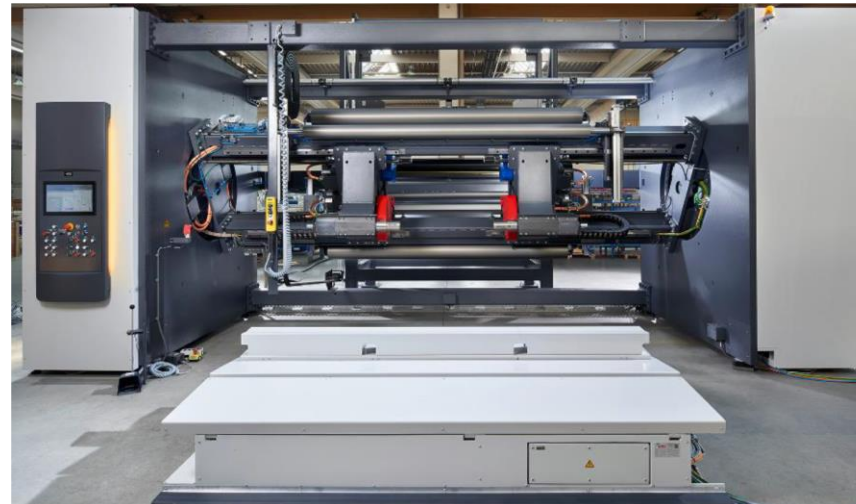

Our offering

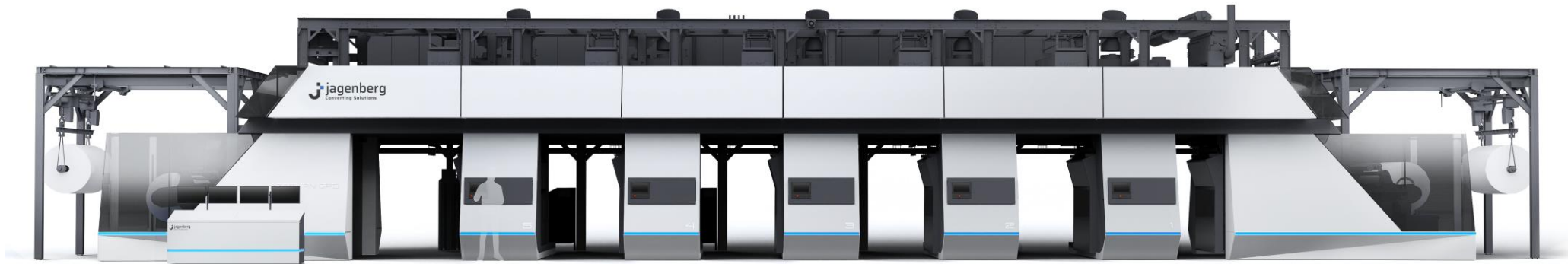

Jagenberg Group

Unique.Surface.Ideas.

Special machine engineering company which develops special solutions for decor applications

Printing units

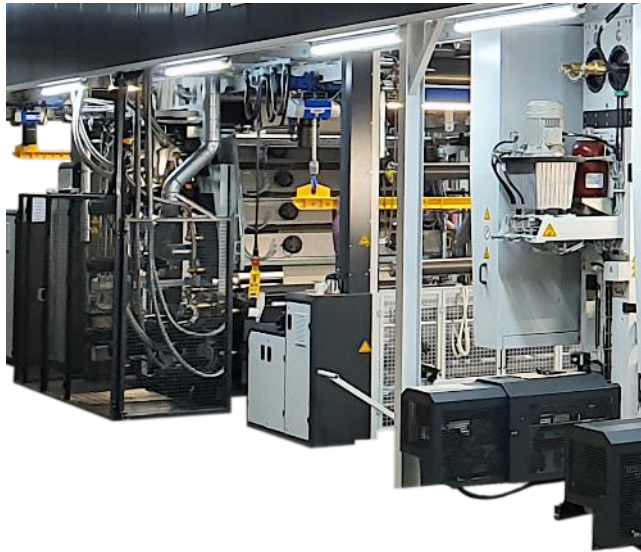

Lacquering units



Web handling

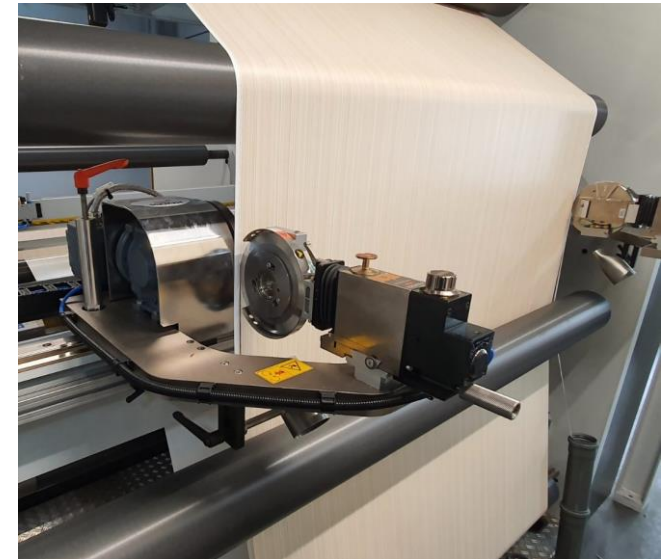

Our offering

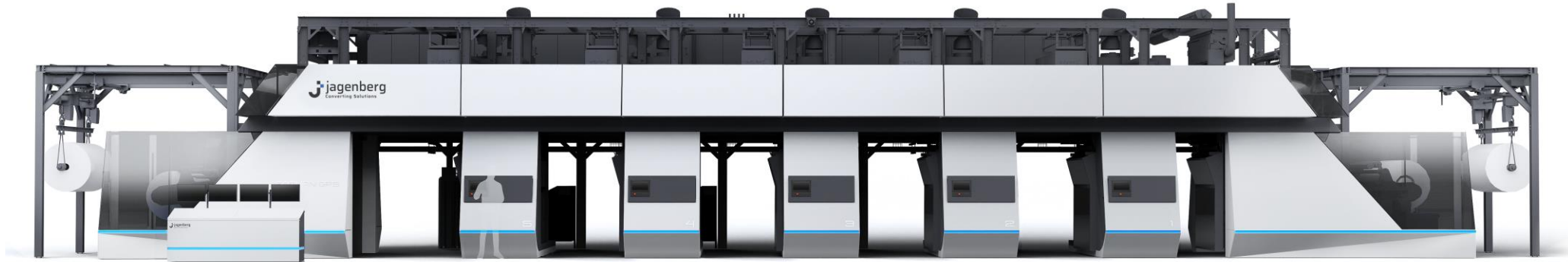

Jagenberg Group

Automation.Drives.Future.

Partner for all questions concerning drive and automation technology. Conceptual design, construction and production of electrical and switchgear systems

Drive technology

Mechatronic drive concepts.
From operating units to cabinet rows or complex switchgear containers for large systems.

Control technology

PLC & HMI operating and monitoring systems.
Pioneering technologies for operation and monitoring and for process visualization.

Data systems

Software development/ visualization systems.
Development of comprehensive visualizations with maximum transparency across all layers.

Panel shop

CE and UL certified panel shop.
With our own panel shop, we provide highest reliability for your delivery schedule.

Start up

Electrical installation / commissioning.
Team of globally experienced professional technicians and engineers for the installation and commissioning of systems "on-site".



Our offering

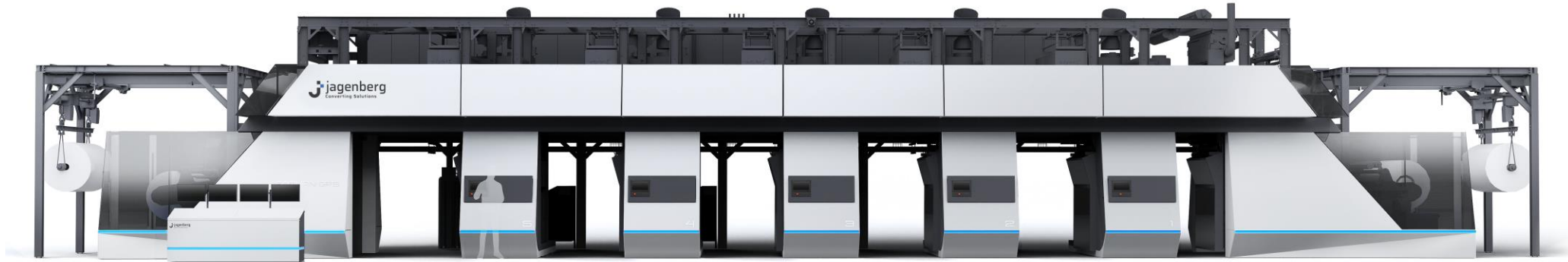

Automation.Drives.Future.

Lauer CE-Safety

For more than 25 years an expert in all issues relating to CE marking, risk assessment, functional safety, assembly instruction and machine safety

CE Marking & Risk assessment

CE compliance.

From precise risk analysis and risk evaluation following the applicable directives to comprehensive research and analysis of standards (i.e. DIN EN ISO 12100) as well as safety-related review of machinery under construction.

User manuals & assembly instructions

Operating instructions and technical documentation.

We provide full service in creating complete preparation of operating and assembling instructions or alternatively evaluates pre-prepared technical documentation and supports the creating process at the customers site by training.

Functional Safety Engineering (FSE)

EN ISO 13849 application.

Our specially trained control engineers support machinery constructors by designing, verifying and validating safety functions.

Professional CE-software

Directives, risks and draw up manuals.

With the right software, these tasks can be completed faster and more efficiently. We offer proven CE-software products that are continuously updated.

Our offering

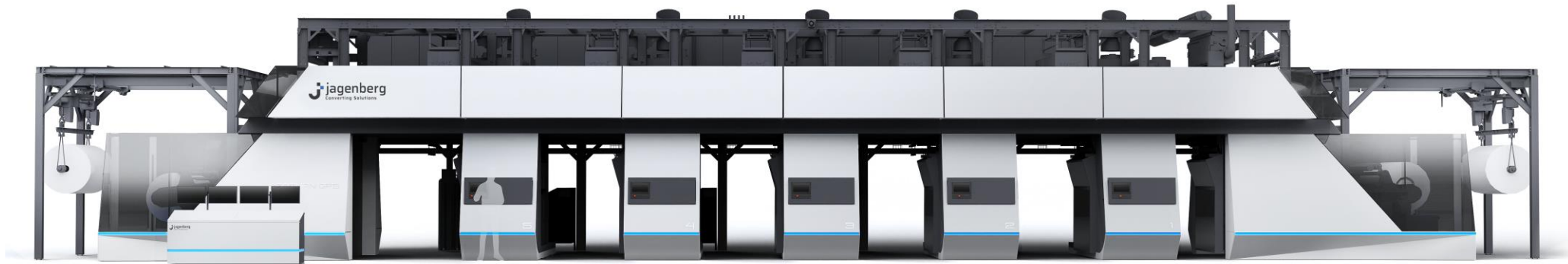

Connect.Develop.Advance.

We focus on improving processes in production and thus optimizing the efficiency of companies across the entire value chain

IloT platform

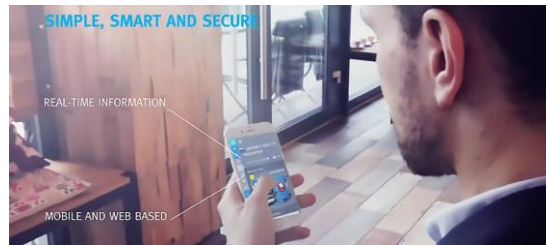

IloT for your equipment.
The platform offers digital intelligence for manufacturing. It connects machines, production and companies. It monitors production and bundles all relevant information for high production quality, resource conservation and low downtimes

Data management



Digitized manufacturing.
Manufacturing is brought to a new level. Our solutions enable direct interfaces to ERP-Systems, communication to MES-Systems as well as support traceability through roll protocols

Smart sensors



Smart data harvester.
There are many different factors that can influence maintenance cycles and product quality. the@dge unit is simply installed and connected via LAN cable (PoE) and communicates with our IloT platform.

How to reach us

Guido Lebbing
Managing Director Surfaces



guido.lebbing@jagenberg-converting.com

Jagenberg Converting Solutions GmbH

Konrad-Zuse-Str. 16
46397 Bocholt

info@jagenberg-converting.com